

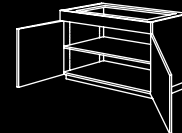

CABINET DESIGN GUIDE

The cabinet design samples on the following pages are subdivided as follows:

Base Cabinets w/o drawers	100 series
Base Cabinets w/ drawers	200 series
Wall Hung Cabinets	300 series
Tall Storage Cabinets	400 series

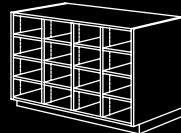
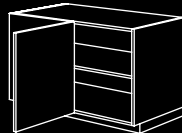
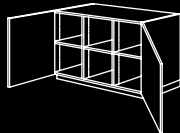
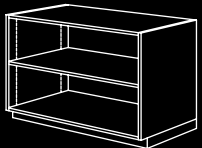

100 SERIES - Base Cabinets w/o Drawers

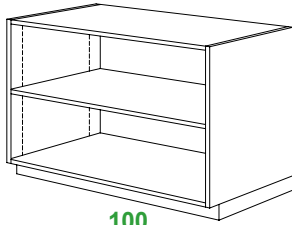

100
Open

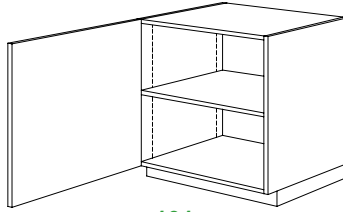

101

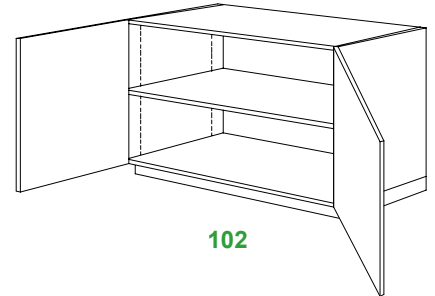

102

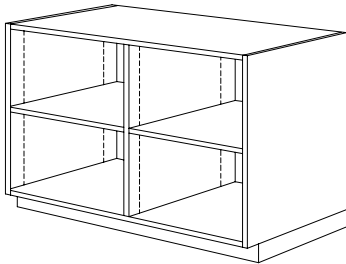

110
Open

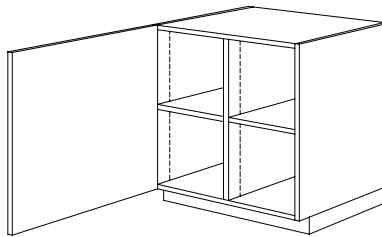

111

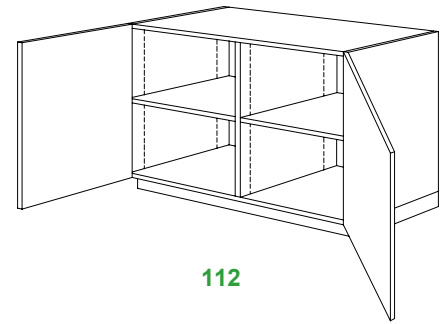

112

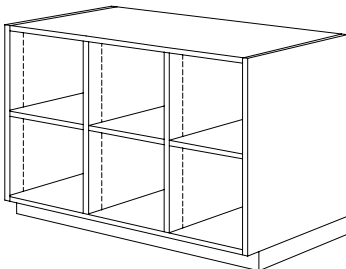

120
Open

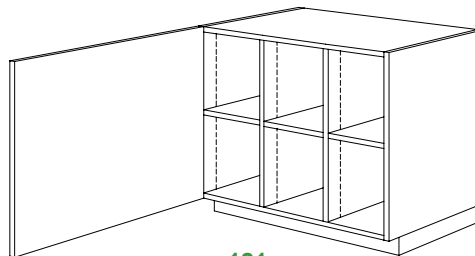

121

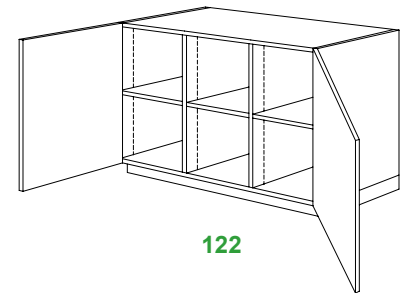

122

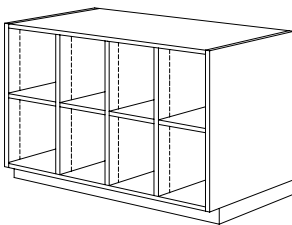

130
Open

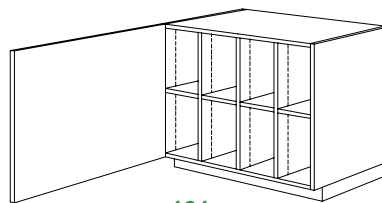

131

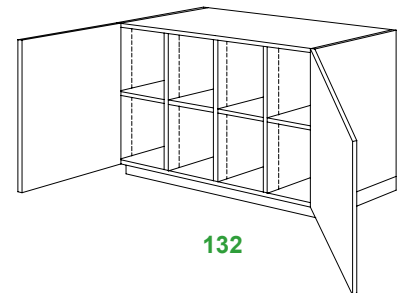

132

100 SERIES - Base Cabinets w/o Drawers

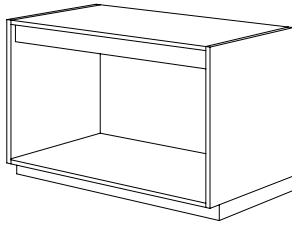

140

- Open / Sink
- Specify Apron Size
- Apron Loose

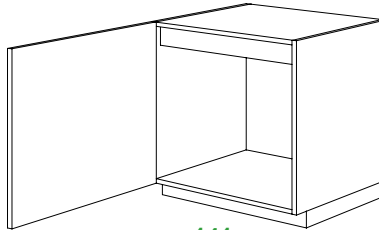

141

- Open / Sink
- Specify Apron Size
- Apron Loose

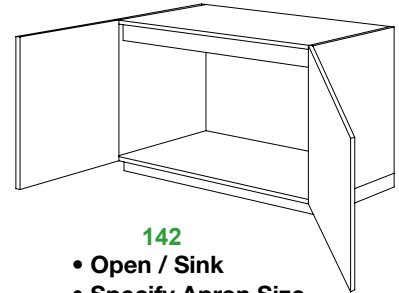

142

- Open / Sink
- Specify Apron Size
- Apron Loose

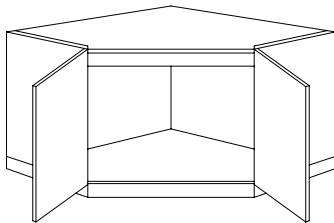

148

- Apron behind Doors
- Specify Apron Size
- Apron Loose

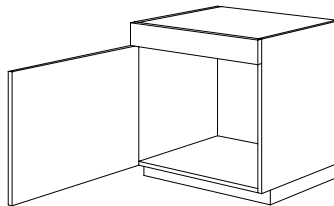

151

- Sink
- False Drawer Front
- Includes Drawer Apron

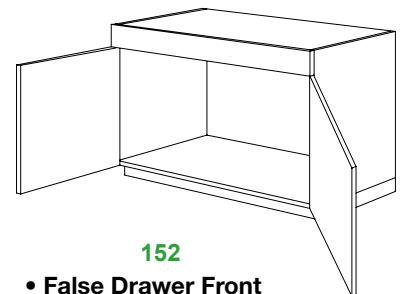

152

- False Drawer Front
- Includes Drawer Apron

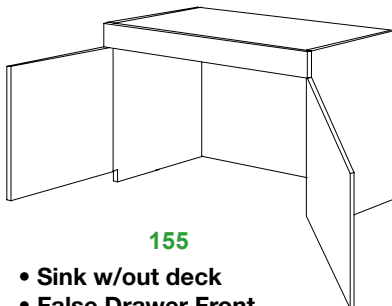

155

- Sink w/out deck
- False Drawer Front
- Includes Drawer Stretcher

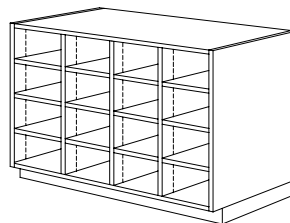

170

Drawer

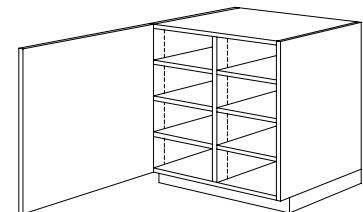

171

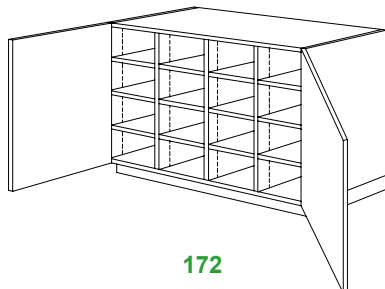

172

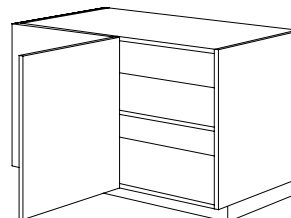

176

- Blind Corner
- Specify Blind Panel Width
- Specify Blank Panel Side (LH or RH)
- Top Drawer Option Available

100 SERIES - Base Cabinets w/o Drawers

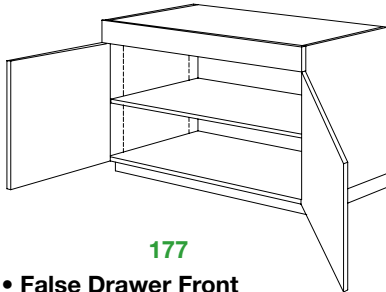

177

- False Drawer Front
- Includes Drawer Stretcher

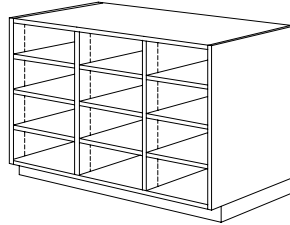

180

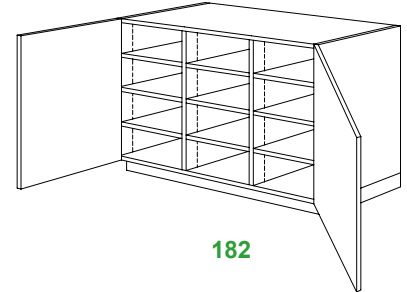

182

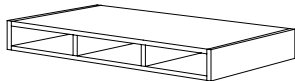

192

- Storage Apron Open

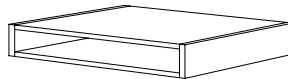

190

- Storage Apron Open

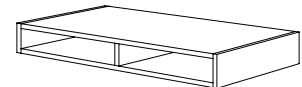

191

- Storage Apron Open

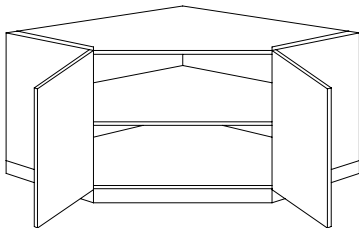

186

- Corner
- Specify Side Depth
- Specify Back Scribe Space

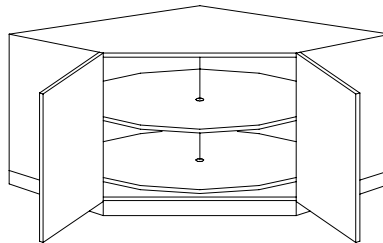

196

- Corner / Lazy Susan
(hardware not included)
- Specify Side Depth
- Specify Back Scribe Space

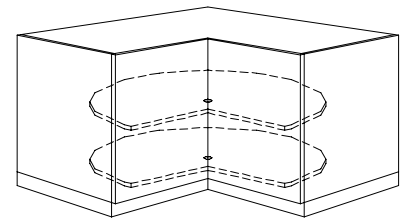

197

- Corner / Lazy Susan
(hardware not included)
- Specify Side Depth
- Specify Back Scribe Space

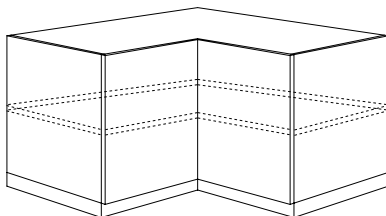

198

- Corner
- Specify Side Depth
- Specify Back Scribe Space

200 SERIES - Base Cabinets with Drawers

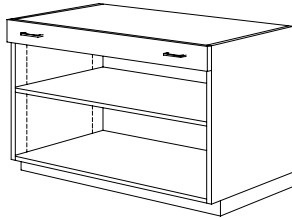

210
Open, Single Drawer

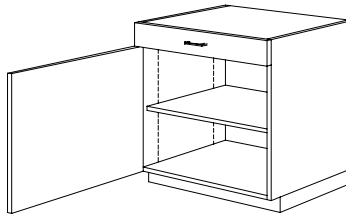

211

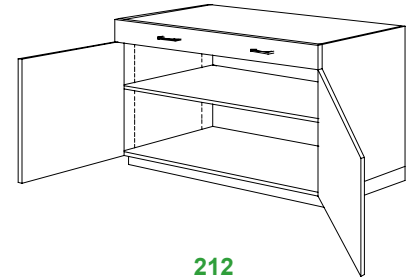

212

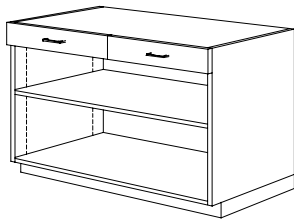

220
Open, Two Drawers

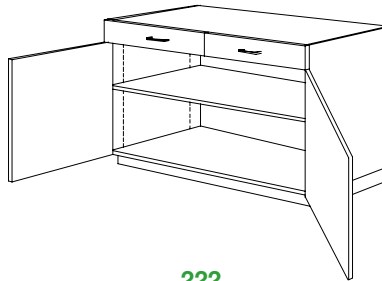

222
Two Drawers

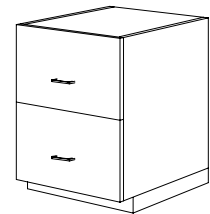

223

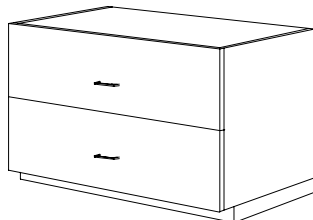

224

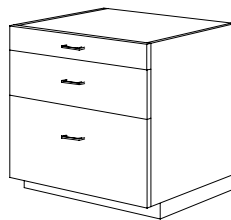

230
Specify Drawer Heights

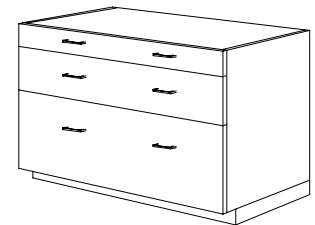

231
Specify Drawer Heights

200 SERIES - Base Cabinets with Drawers

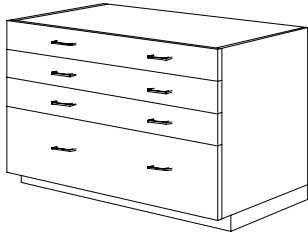

240
Specify Drawer Heights

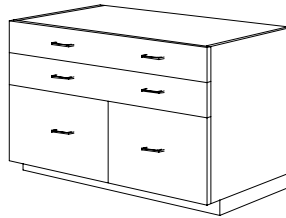

242
Specify Drawer Heights

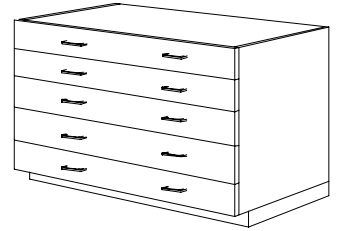

250

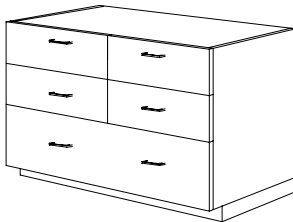

251

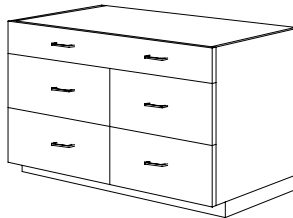

252

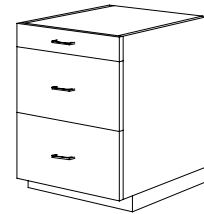

253



254
Specify Drawer Heights

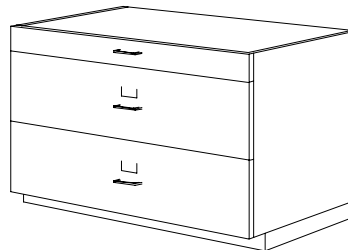

255
Specify Drawer Heights



260
Equal Drawer Heights

200 SERIES - Base Cabinets with Drawers

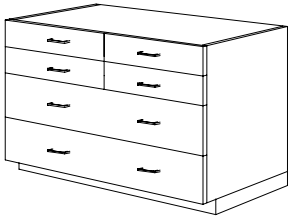

261

Specify Drawer Heights



262



270

Equal Drawer Heights

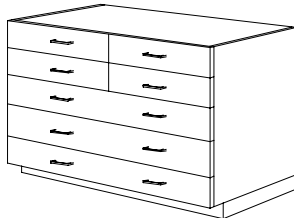

271

Specify Drawer Heights



272

Specify Drawer Heights

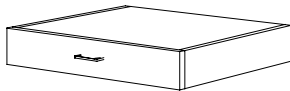

290

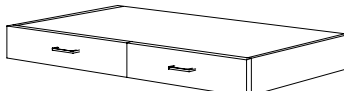

291

Drawer Apron

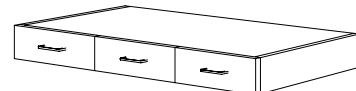

292

Drawer Apron

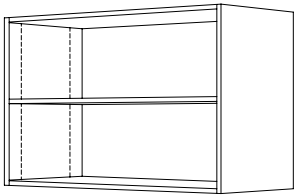

300
Open

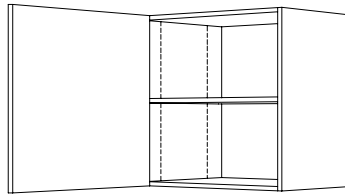

301
Single Door

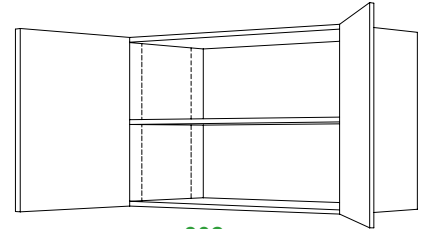

302
Double Door

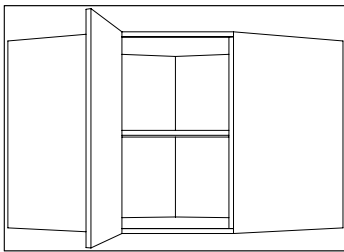

308
Specify 45° or 90° L-Shape Corner
Specify Side Depth
Specify Back Scribe Space

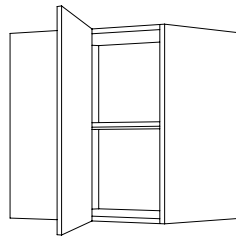

309
Blind Corner
Specify Blind Panel Width
Specify Blank Panel Side (LH or RH)

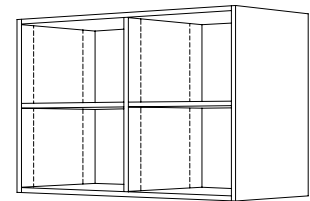

310
Open

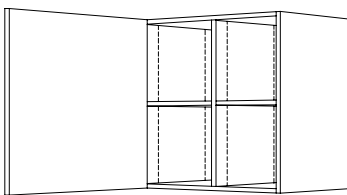

311
Single Door

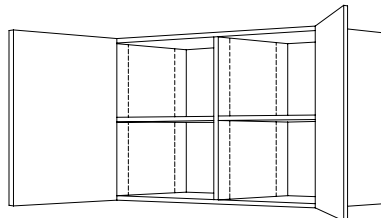

312

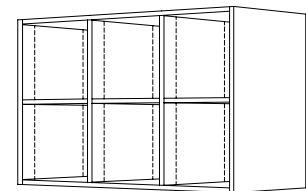

320
Open

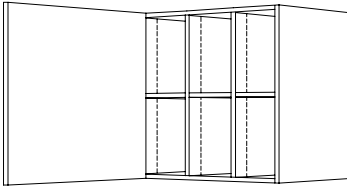

321
Single Door

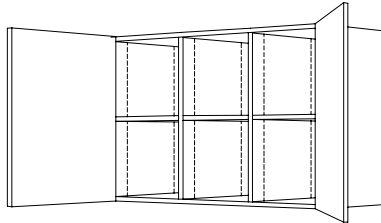

322
Double Door

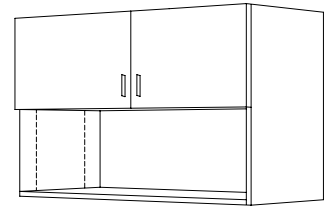

326
Specify Bottom Edge of Doors
Fixed Shelf is flush with doors

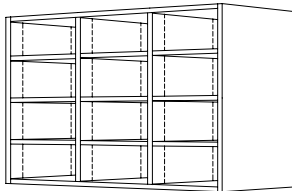

340
open

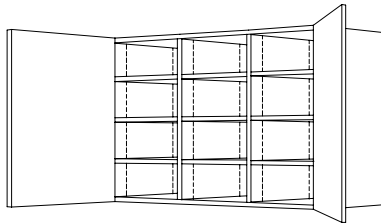

342
Double Door

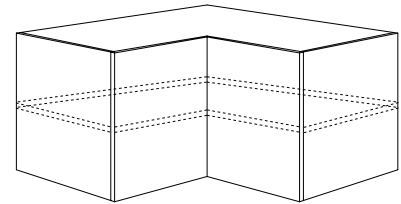

398
90° Corner / Upper
Specify Side Depth
Specify Back Scribe Space

400 SERIES - Tall Storage Cabinets

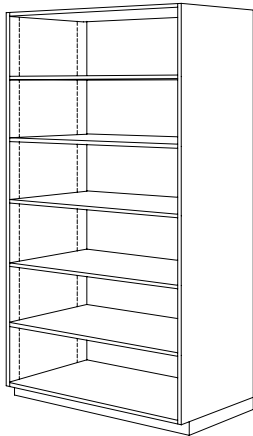

400
No Doors

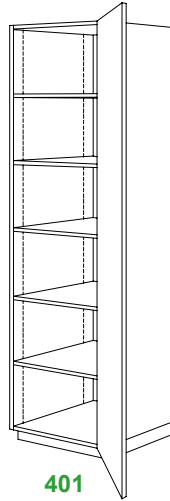

401
Single Door

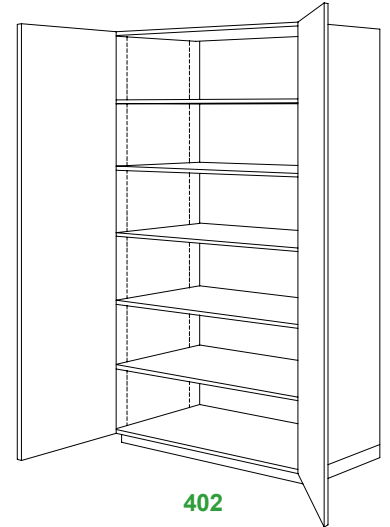

402
Double Door

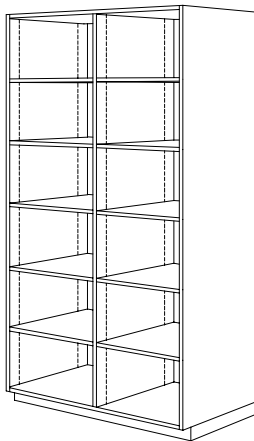

410
No Doors

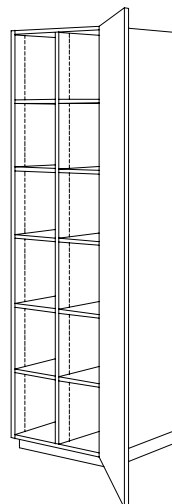

411
Single Door

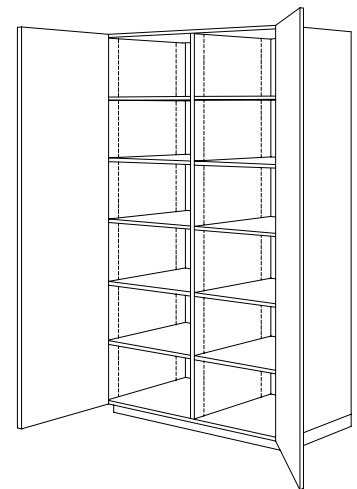

412
Double Door

400 SERIES - Tall Storage Cabinets

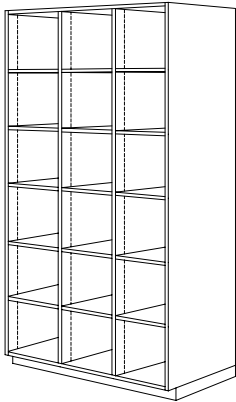

420

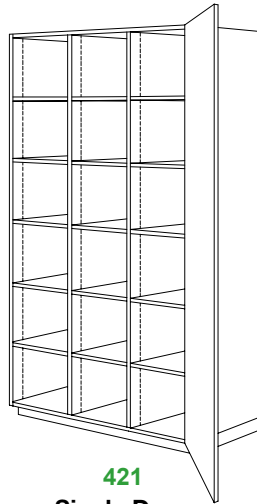

421
Single Door

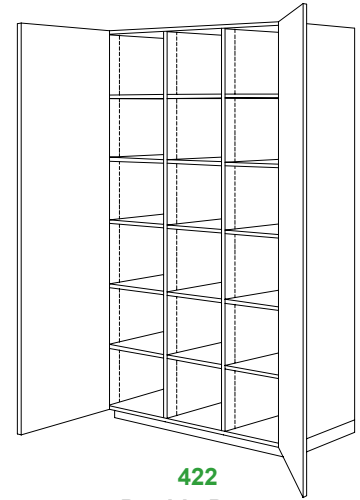

422
Double Door

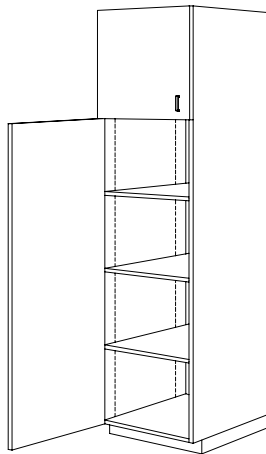

423
Split Height
Specify Bottom Door Height

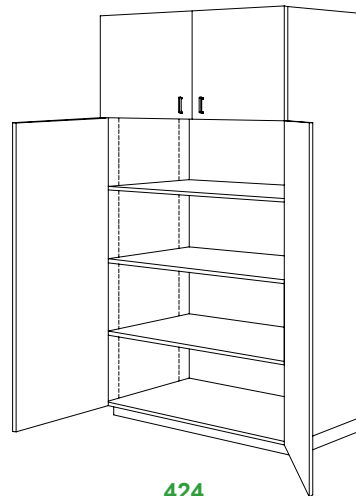

424
Specify Split Height
Specify Bottom Door Height

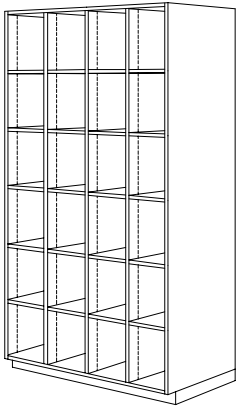

430
No Doors

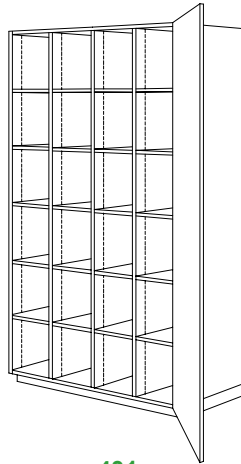

431
Single Door

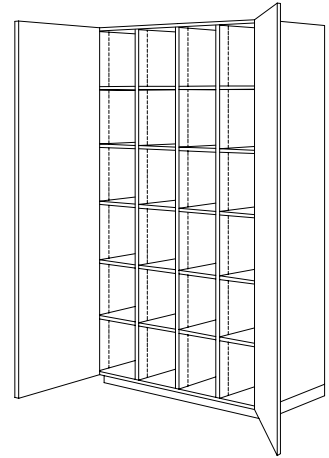

432
Double Door

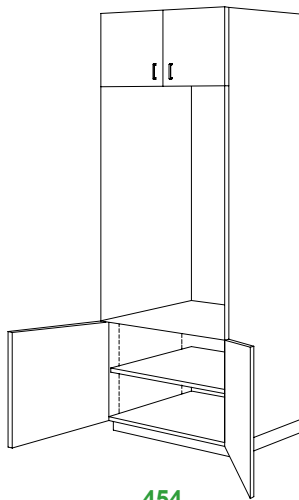

454

Specify Bottom of Cabinet to
Bottom of Oven Opening
Specify Oven Opening Height
Specify Doors or Drawer Below